

# Shower Door Hardware

CRL - the world's largest supplier  
of Frameless Shower products

Create your perfect bathroom with  
our extensive range of Shower  
Hardware and accessories.

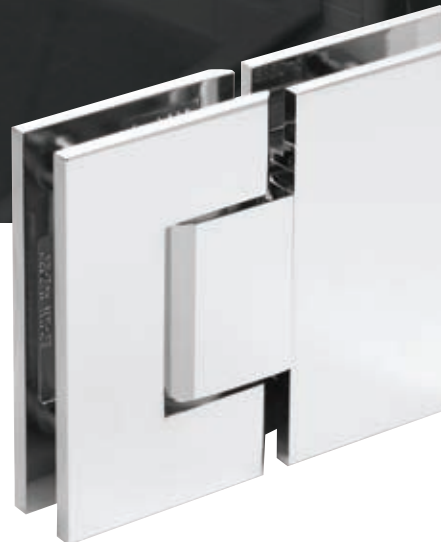



# Shower Door Hardware

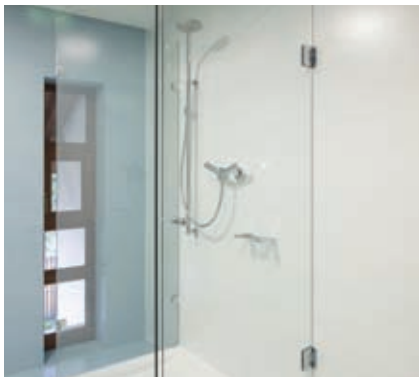

Inside this brochure you will find a selection of our best selling shower door products taken from our full, industry leading range.

From complete systems such as the popular CRL Hydroslide Sliding Shower Door Kit and the new CRL Serenity Series Sliding Door System, to accessories such as Hinges, Handles, Door Knobs, Channels and Clamps, CRL offers the complete package of quality hardware and accessories.

CRL offers the largest variety of Frameless Shower Door Hardware in the glass industry.

Hinges **04-15**

Sliding Shower Door Kits **16-18**

U-Channels **19**

Glass Door Clamps **22-24**

Pull Handles & Knobs **25**

Support Bars & Headers **28-32**

Glass Door Locks **33**

Towel Bars **34-35**

Shower Door Seals **36-37**

Shower Hardware & Accessories **38-39**

Colour Range **Back Cover Flap**

**CRL**<sup>®</sup>  
crlaurence.co.uk

For more information call FREE on

**00 800 0421 6144**

e: CRL@crlaurence.co.uk f: 00 800 0262 3299



## Specifications

**Glass Thickness:** 8mm to 12mm Toughened Safety Glass

**Special Feature:** Offers choice of Standard Model factory set at standard closing position 0°, or 5° Pre-Set Model for tighter closure into shower interior

**Construction:** Solid Brass

**Hinge Swings:** 90° in and 90° out

**Closing Type:** Self-centring when within 15° of closed position.

**Cut-Out Required**

**Includes:** Gaskets, Screws, and Glass Fabrication Dimensions

**Standard:** DIN EN14428

**For maximum weight and door width capacities please see [crlaurence.co.uk](http://crlaurence.co.uk)**

## Colours

Chrome version shown below. 20 attractive colours available. For details please see the flip out chart at the rear of this brochure or visit [crlaurence.co.uk](http://crlaurence.co.uk)



View	Cat. No. / Description	View	Cat. No. / Description
	<p><b>Cat. No. GEN037XX</b> Wall Mount Full Back Plate Standard Model (Factory set for standard closing position)</p> <p><b>Cat. No. GEN537XX</b> 5° Pre-Set Model (Factory set for 5° tighter closure into shower interior)</p>		<p><b>Cat. No. GEN180XX</b> 180° Glass-to-Glass Standard Model (Factory set for standard closing position)</p> <p><b>Cat. No. GEN580XX</b> 5° Pre-Set Model (Factory set for 5° tighter closure into shower interior)</p>
	<p><b>Cat. No. GEN074XX</b> Wall Mount Short Back Plate Standard Model</p> <p><b>Cat. No. GEN574XX</b> 5° Pre-Set Model (Factory set for 5° tighter closure into shower interior)</p>		<p><b>Cat. No. GEN045XX</b> 135° Glass-to-Glass Standard Model (Factory set for standard closing position)</p> <p><b>Cat. No. GEN545XX</b> 5° Pre-Set Model (Factory set for 5° tighter closure into shower interior)</p>
	<p><b>Cat. No. GEN044XX</b> Wall Mount Offset Back Plate (Factory set for standard closing position)</p> <p><b>Cat. No. GEN544XX</b> Wall Mount Offset Back Plate (Factory set for standard closing position)</p>		<p><b>Cat. No. GEN092XX</b> 90° Glass-to-Glass</p>

## Pivot Pin

See [crlaurence.co.uk](http://crlaurence.co.uk) for more Pivot Pin information

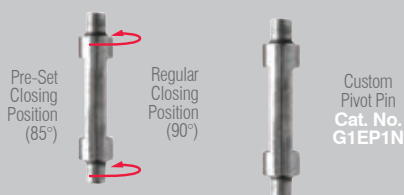

Custom Pivot Pin  
Cat. No. G1EP1N





### Specifications

**Glass Thickness:** 8mm to 12mm Toughened Safety Glass

**Special Feature:** Adjustable to Any Angle Up to 90° Without Having to Take Door Down

**Construction:** Solid Brass

**Hinge Swings:** 90° in and 90° out (at factory set position)

**Closing Type:** Self-centring when within 15° of closed position

**Cut-Out Required**

**Includes:** Gaskets, Screws, and Glass Fabrication Dimensions

**Standard:** DIN EN14428

**NOTE:** Door Glass width may require alteration from standard clearance deductions when adjusting angles. Call for details.

**For maximum weight and door width capacities please see [crlaurence.co.uk](http://crlaurence.co.uk)**

### Colours

Chrome version shown below. 20 attractive colours available. For details please see the flip out chart at the rear of this brochure or visit [crlaurence.co.uk](http://crlaurence.co.uk)



Front View	Rear View	Cat No. / Description
		<b>Cat. No. GEN337XX</b> Adjustable Wall Mount Full Back Plate <span style="background-color: #0070C0; color: white; padding: 2px;">adjustable</span>
		<b>Cat. No. GEN344XX</b> Adjustable Chrome Wall Mount Offset Back Plate <span style="background-color: #0070C0; color: white; padding: 2px;">adjustable</span>
		<b>Cat. No. GEN345XX</b> Adjustable 135° Glass-to-Glass <span style="background-color: #0070C0; color: white; padding: 2px;">adjustable</span>
		<b>Cat. No. GEN380XX</b> Adjustable 180° Glass-to-Glass <span style="background-color: #0070C0; color: white; padding: 2px;">adjustable</span>

## CRL Jamb Mounted Hinge Kits

Our Jamb Mounted Hinge Kits let you provide an 'all-glass' look shower door in an easy-to-install configuration. Water leakage around the door is minimised with the use of extruded aluminum jamba with vinyl for both the hinge and strike sides, and a clear vinyl sweep for the bottom. Kits come in your choice of three of our most popular finishes, with glass cut-out templates and installation instructions enclosed.

**STANDARD HINGE KITS**  
 For 8mm to 12mm Toughened Safety Glass.

1.83m High Geneva Series Kits	GEN03372XX
1.98m High Geneva Series Kits	GEN03378XX
1.83m High Pinnacle Series Kits	P1N03372XX
1.98m High Pinnacle Series Kits	P1N03378XX

**HEAVY DUTY HINGE KITS**  
 For 10mm to 12mm Toughened Safety Glass.

1.83m High Vienna Series Kits	V1E03372XX
-------------------------------	------------



**Suitable for heavier glass**

### Specifications

**Glass Thickness:** 10mm to 12mm  
Toughened Safety Glass

**Construction:** Solid Brass

**Hinge Swings:** 90° in and 90° out

**Closing Type:** Self-centring when within 15° of closed position

### Cut-Out Required

**Includes:** Gaskets, Screws, and Glass Fabrication Dimensions

**Standard:** DIN EN14428

**For maximum weight and door width capacities please see [crlaurence.co.uk](http://crlaurence.co.uk)**

### Colours

Chrome version shown below. 20 attractive colours available. For details please see the flip out chart at the rear of this brochure or visit [crlaurence.co.uk](http://crlaurence.co.uk)



## View      Cat No. / Description



**Cat. No. V1E037XX**  
Wall Mount Full Back Plate  
Standard Model (Factory set for standard closing position)  
**Cat. No. V1E537XX**  
5° Pre-Set Model  
(Factory set for 5° tighter closure into shower interior)



**Cat. No. V1E044XX**  
Wall Mount Offset Back Plate Standard Model  
(Factory set for standard closing position)  
**Cat. No. V1E544XX**  
5° Pre-Set Model  
(Factory set for 5° tighter closure into shower interior)



**Cat. No. V1E045XX**  
135° Glass-to-Glass

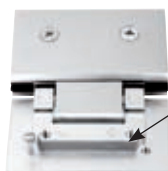

Internal View of Vienna Hinge

Pin In Place (For "Mouse Ears" Cut-Out)

Pin Removed (For Square Corner Cut-Out)

## View      Cat No. / Description



**Cat. No. V1E074XX**  
Wall Mount Short Back Plate



**Cat. No. V1E180XX**  
180° Glass-to-Glass Standard Model  
(Factory set for standard closing position)

**Cat. No. V1E580XX**  
5° Pre-Set Model (Factory set for 5° tighter closure into shower interior)



**Cat. No. V1E092XX**  
90° Glass-to-Glass

### Pivot Pin

See [crlaurence.co.uk](http://crlaurence.co.uk) for more Pivot Pin information

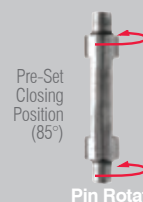



### Specifications

**Glass Thickness:** 10mm to 12mm Toughened Safety Glass

**Special Feature:** Adjustable to Any Angle Up to 90 Degrees Without Having to Take Door Down

**Construction:** Solid Brass

**Hinge Swings:** 90° in and 90° out (at factory set position)

**Closing Type:** Self-centring when within 15° of closed position

### Cut-Out Required

**Includes:** Gaskets, Screws, and Glass Fabrication Dimensions

**Standard:** DIN EN14428

**NOTE:** Door Glass Width May Require Alteration From Standard Clearance Deductions When Adjusting Angles. Call for Details.

**For maximum weight and door width capacities please see [crlaurence.co.uk](http://crlaurence.co.uk)**

### Colours

Chrome version shown below. 20 attractive colours available. For details please see the flip out chart at the rear of this brochure or visit [crlaurence.co.uk](http://crlaurence.co.uk)



Front View

Rear View

Cat No. / Description



Allen Adjustment Screws

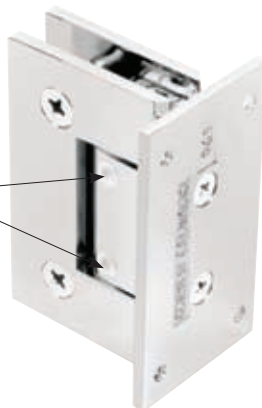

**Cat. No. V1E337XX**  
Adjustable Wall Mount Full Back Plate

adjustable



Allen Adjustment Screws



**Cat. No. V1E380XX**  
Adjustable 180° Glass-to-Glass  
Adjustable Hinges open to 90°, only adjustable to 45°

adjustable

# CRL Pinnacle Series



## Specifications

**Glass Thickness:** 8mm to 12mm Toughened Safety Glass

**Special Feature:** Wall Mount Hinges and 180° Glass-to-Glass Hinge offer a choice of a Standard Model, factory set at standard closing position (0°), or a 5° Pre-Set Model for tighter closure into shower interior

**Construction:** Solid Brass

**Hinge Swings:** 90° in and 90° out

**Closing Type:** Self-centring when within 15° of closed position

**Cut-Out Required**

**Includes:** Gaskets, Screws, and Glass Fabrication Dimensions







**Standard:** DIN EN14428

**For maximum weight and door width capacities please see [crlaurence.co.uk](http://crlaurence.co.uk)**

## Colours

Chrome version shown below. 20 attractive colours available. For details please see the flip out chart at the rear of this brochure or visit [crlaurence.co.uk](http://crlaurence.co.uk)



View	Cat. No. / Description	View	Cat. No. / Description
	<p><b>Cat. No. P1N037XX</b> Wall Mount Full Back Plate Standard Model (Factory set for standard closing position)</p> <p><b>Cat. No. P1N537XX</b> 5° Pre-Set Model (Factory set for 5° tighter closure into shower interior)</p>		<p><b>Cat. No. P1N180XX</b> 180° Glass-to-Glass Standard Model (Factory set for standard closing position)</p> <p><b>Cat. No. P1N580XX</b> 5° Pre-Set Model (Factory set for 5° tighter closure into shower interior)</p>
	<p><b>Cat. No. P1N074XX</b> Wall Mount Short Back Plate Standard Model (Factory set for standard closing position)</p> <p><b>Cat. No. P1N574XX</b> 5° Pre-Set Model (Factory set for 5° tighter closure into shower interior)</p>		<p><b>Cat. No. P1N045XX</b> 135° Glass-to-Glass</p>
	<p><b>Cat. No. P1N044XX</b> Wall Mount Offset Back Plate Standard Model (Factory set for standard closing position)</p> <p><b>Cat. No. P1N544XX</b> 5° Pre-Set Model (Factory set for 5° tighter closure into shower interior)</p>		<p><b>Cat. No. P1N092XX</b> 90° Glass-to-Glass</p>

## Pivot Pin

See [crlaurence.co.uk](http://crlaurence.co.uk) for more Pivot Pin information

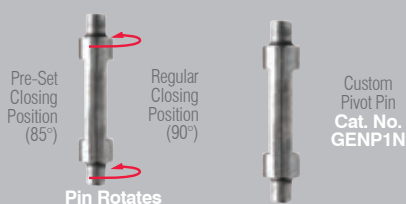

Custom Pivot Pin  
Cat. No. GENP1N





### Specifications

**Glass Thickness:** 8mm to 12mm Toughened Safety Glass

**Special Feature:** Adjustable to any angle up to 90° without having to take door down

**Construction:** Solid Brass

**Hinge Swings:** 90° in and 90° out (at factory set position)

**Closing Type:** Self-centring when within 15° of closed position

**Cut-Out Required**

**Includes:** Gaskets, Screws, and Glass Fabrication Dimensions

**Standard:** DIN EN14428

**NOTE:** Door Glass width may require alteration from standard clearance deductions when adjusting angles. Call for details.

**For maximum weight and door width capacities please see [crlaurence.co.uk](http://crlaurence.co.uk)**

### Colours

Chrome version shown below. 20 attractive colours available. For details please see the flip out chart at the rear of this brochure or visit [crlaurence.co.uk](http://crlaurence.co.uk)



Front View	Rear View	Cat No. / Description
		<b>Cat. No. P1N337XX</b> Adjustable Wall Mount Full Back Plate <b>adjustable</b>
		<b>Cat. No. P1N344XX</b> Adjustable Wall Mount Offset Back Plate <b>adjustable</b>
		<b>Cat. No. P1N345XX</b> Adjustable 135° Glass-to-Glass <b>adjustable</b>
		<b>Cat. No. P1N380XX</b> Adjustable 180° Glass-to-Glass <b>adjustable</b>



**Suitable for heavier glass**

### Specifications

**Glass Thickness:** 10mm to 12mm Toughened Safety Glass

**Construction:** Solid Brass

**Hinge Swings:** 90° in and 90° out

**Closing Type:** Self-centring when within 15° of closed position

**Cut-Out Required**

**Includes:** Gaskets, Screws, and Glass Fabrication Dimensions





**Standard:** DIN EN14428

**For maximum weight and door width capacities please see [crlaurence.co.uk](http://crlaurence.co.uk)**

### Colours

Chrome version shown below. 19 attractive colours available. For details please see the flip out chart at the rear of this brochure or visit [crlaurence.co.uk](http://crlaurence.co.uk)

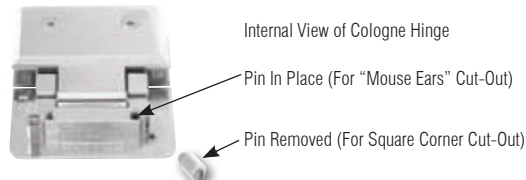
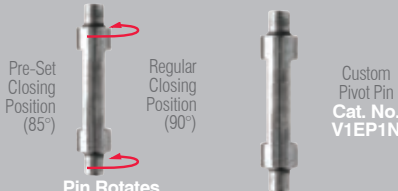

View	Cat No. / Description	View	Cat No. / Description
	<p><b>Cat. No. C0L037XX</b> Wall Mount Full Back Plate Standard Model</p> <p><b>Cat. No. C0L537XX</b> 5° Pre-Set Model (Factory set for 5° tighter closure into shower interior)</p>		<p><b>Cat. No. C0L180XX</b> 180° Glass-to-Glass</p>
	<p><b>Cat. No. C0L044XX</b> Wall Mount Offset Back Plate Standard Model (Factory set for standard closing position)</p> <p><b>Cat. No. C0L544XX</b> 5° Pre-Set Model (Factory set for 5° tighter closure into shower interior)</p>		<p><b>Cat. No. C0L045XX</b> 135° Glass-to-Glass</p>
	<p><b>Cat. No. C0L092XX</b> 90° Glass-to-Glass</p>		<p>Internal View of Cologne Hinge</p> <p>Pin In Place (For "Mouse Ears" Cut-Out)</p> <p>Pin Removed (For Square Corner Cut-Out)</p>
<p><b>Pivot Pin</b> See <a href="http://crlaurence.co.uk">crlaurence.co.uk</a> for more Pivot Pin information</p>  <p>Pre-Set Closing Position (85°)      Regular Closing Position (90°)</p> <p>Pin Rotates</p> <p>Custom Pivot Pin Cat. No. V1EP1N</p>			



### Specifications

**Glass Thickness:** 10mm to 12mm Toughened Safety Glass

**Special Feature:** Adjustable to any angle up to 90° without having to take door down

**Construction:** Solid Brass

**Hinge Swings:** 90° in and 90° out (at factory set position)

**Closing Type:** Self-centring when within 15° of closed position

**Cut-Out Required**

**Includes:** Gaskets, Screws, and Glass Fabrication Dimensions

**Standard:** DIN EN14428

**NOTE:** Door Glass width may require alteration from standard clearance deductions when adjusting angles. Call for details.

**For maximum weight and door width capacities please see [crlaurence.co.uk](http://crlaurence.co.uk)**

### Colours

Chrome version shown below. 17 attractive colours available. For details please see the flip out chart at the rear of this brochure or visit [crlaurence.co.uk](http://crlaurence.co.uk)



Front View	Rear View	Cat No. / Description
------------	-----------	-----------------------

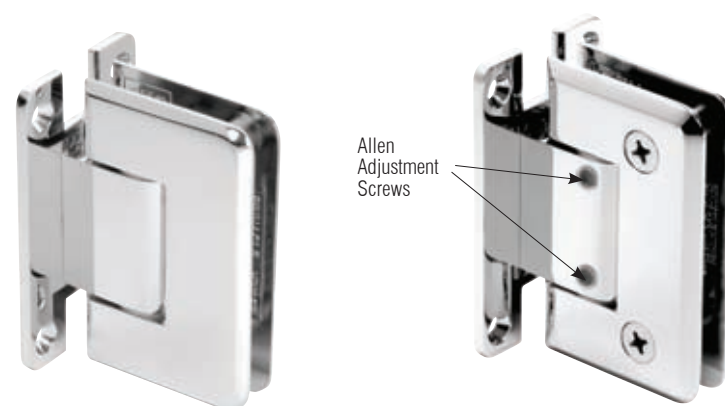

**Cat. No. C0L337XX**  
Adjustable Wall Mount Full Back Plate



**Cat. No. C0L380XX**  
Adjustable 180° Glass-to-Glass



# CRL Madrid Series Hinge / Clamp



## Specifications

### Glass Thickness:

8mm to 10mm Fixed Toughened Safety Glass  
10mm to 12mm Door Toughened Safety Glass

**Construction:** Solid Brass

**Hinge Swings:** Out only

**Closing Type:** Tight Closure to Strike Jamb  
(Not Supplied)

**No Cut-Out for Door; Fabrication Required for Fixed Panel Being Hinged From**

**Includes:** Gaskets and Mounting Hardware

**This Hinge Series is Patented (Patent Number 7,607,199)**

**For maximum weight and door width capacities please see [crlaurence.co.uk](http://crlaurence.co.uk)**

**\*Mandatory** use of 25 or 38mm heavy weight wall Dry Glaze U-Channel and Vinyl.

## Colours

Chrome version shown below. 5 attractive colours available. For details please see the flip out chart at the rear of this brochure or visit [crlaurence.co.uk](http://crlaurence.co.uk)

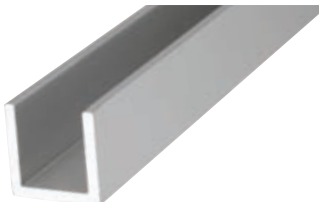

View	Cat No. / Description	View	Cat No. / Description
 <p><b>For 10mm and 12mm glass</b></p>	<p><b>Cat. No. MA06RHXX</b> Right Hand For 10mm door and 12mm fixed panel</p>	 <p><b>For 10mm and 12mm glass</b></p>	<p><b>Cat. No. MA06LHXX</b> Right Hand For 10mm door and 12mm fixed panel</p>
 <p><b>For 8 and 10mm glass</b></p>	<p><b>Cat. No. MA07RHXX</b> Right Hand For 8mm door and 10mm fixed panel</p>	 <p><b>For 8 and 10mm glass</b></p>	<p><b>Cat. No. MA07LHXX</b> Right Hand For 8mm door and 10mm fixed panel</p>
<p><b>IMPORTANT ORDERING TIPS:</b> The MA06 and MA07 Hinge Sets are supplied complete with two Hinge/Clamps. When an order is placed for either the MA06 or MA07, one Hinge/Clamp for the top and one Hinge/Clamp for the bottom will be provided. The Hinge Sets are ordered as "Left Hand" or "Right Hand", as viewed from the outside of the shower. As an example, an MA06L is a set of both top and bottom hinges mounted to the left side of a door, when viewed from the outside of the shower. An MA06R is a set of both top and bottom hinges mounted to the right side of a door, when viewed from the outside of the shower.</p>			<p><b>Cat. No. WU3SASL*</b> Satin Anodised 25mm Deep Dry Glaze U-Channel  (Also available in Brite Anodised, Brite Gold Anodised, Brushed Nickel Anodised and Painted Oil Rubbed Bronze finishes)</p>
<p><b>Gaskets</b> <b>Cat. No. RG38100</b> For 10mm fixed panel  <b>Cat. No. RG12100</b> For 12mm fixed panel</p>			<p><b>Cat. No. WU1SASL*</b> Satin Anodised 38mm Shallow Dry Glaze U-Channel  (Also available in Brite Anodised, Brite Gold Anodised, Brushed Nickel Anodised and Painted Oil Rubbed Bronze finishes)</p>





## Specifications

**Glass Thickness:** 8 to 10mm Toughened Safety Glass

**Special Feature:** Have ability to be side mounted at top and bottom corners of the door, or anywhere in-between. Corner mounting allows more glass exposure

**Construction:** Solid Brass

**Hinge Swings:** 90° in and 90° out (at factory set position)

**Closing Type:** Precise closing to 0 Degrees.

**Cut-Out and Hole Required**

**Includes:** One Hinge, Gaskets, Screws and Template

**Standard:** DIN EN14428

**For maximum weight and door width capacities please see [crlaurence.co.uk](http://crlaurence.co.uk)**

## Colours

Chrome version shown below. 8 attractive colours available. For details please see the flip out chart at the rear of this brochure or visit [crlaurence.co.uk](http://crlaurence.co.uk)



View	Cat. No. / Description	View	Cat. No. / Description
	<b>Cat. No. GRA037XX</b> Grande Wall Mount Standard Back Plate Hinge		<b>Cat. No. GRA337XX</b> Adjustable Standard Wall Mount Grande Series Hinge <b>adjustable</b>
	<b>Cat. No. GRA044XX</b> Grande Wall Mount Offset Back Plate Hinge		<b>Cat. No. GRA344XX</b> Adjustable Offset Wall Mount Grande Series Hinge <b>adjustable</b>
	<b>Cat. No. GRA090XX</b> Grande 90 Degree Glass-to-Glass Hinge		<b>Cat. No. GRA390XX</b> Adjustable 90 Degree Glass-to-Glass Grande Series Hinge <b>adjustable</b>
	<b>Cat. No. GRA180XX</b> Grande 180 Degree Glass-to-Glass Hinge <b>135 Degree Glass-to-Glass Hinge also available (GRA135XX)</b>		<b>Cat. No. GRA380XX</b> Adjustable 180 Degree Glass-to-Glass Grande Series Hinge <b>adjustable</b>



## Specifications

**Glass Thickness:** 8mm to 10mm Toughened Safety Glass

**Special Feature:** Top and Bottom Mount design allows more glass to show. Use of these hinges reduce quantity of cut-outs required when compared to standard side mount glass-to-glass hinges. Cat. No. PPH01 can be mounted floor and ceiling, or floor and header

**Construction:** Solid Brass

**Hinge Swings:** Full Rotation

**Closing Type:** Self-centring when within 15° of closed position

**Cut-Out Required**

**Includes:** Gaskets, Screws, and Glass Fabrication Dimensions

**This hinge series is patented (Patent Number 5297313)**

**For maximum weight and door width capacities please see [crlaurence.co.uk](http://crlaurence.co.uk)**

**Pivot Pin Available**  
See [crlaurence.co.uk](http://crlaurence.co.uk) for more information

## Colours

Chrome version shown below. 20 attractive colours available. For details please see the flip out chart at the rear of this brochure or visit [crlaurence.co.uk](http://crlaurence.co.uk)



View	Cat. No. / Description	View	Cat. No. / Description
	<b>Cat. No. PPH01XX</b> Top or Bottom Mount Can be adapted to Deluxe Header Kit		<b>Cat. No. PPH03XX</b> L-Bracket Wall Mount
	<b>Cat. No. PPH06XX</b> Top Mount Compatible only with EZ-Adjust Header. Use Cat. No. PPH01 as bottom hinge.		<b>Cat. No. PPH135LXX</b> 135° Glass-to-Glass Left Hand Mount when viewed from outside of shower
	<b>Cat. No. PPH02XX</b> Glass-to-Fixed Transom Mount		<b>Cat. No. PPH135RXX</b> 135° Glass-to-Glass Right Hand Mount when viewed from outside of shower
	<b>Cat. No. PPH07XX</b> Top or Bottom Mount with Attached U-Clamp		<b>Cat. No. PPH05LXX</b> Offset Bracket Wall Mount Left Hand Mount when viewed from outside of shower
			<b>Cat. No. PPH05RXX</b> Offset Bracket Wall Mount Right Hand Mount when viewed from outside of shower
			<b>adjustable</b> <b>Cat. No. PPH301XX</b> CRL Chrome Adjustable Prima Series Hinge

# CRL Junior & Senior Prima Series



## Specifications

**Glass Thickness:** Prima Senior - 12mm Toughened Safety Glass

**Glass Thickness:** Prima Junior - 6mm Toughened Safety Glass

**Junior Prima Special Feature:** Top and bottom mount allows more glass exposure. Can also save on glass fabrication costs when compared to use of Side Mount Glass-to-Glass Hinges requiring more cut-outs.

**Construction:** Solid Brass

**Hinge Swings:** Full Rotation

**Closing Type:** Self-centring when within 15° of closed position

**Cut-Out Required**

**Includes:** Gaskets, Screws, and Glass Fabrication Dimensions. Adjustable Prima also includes 3mm Allen Wrench.





**For maximum weight and door width capacities please see [crlaurence.co.uk](http://crlaurence.co.uk)**

**Pivot Pin Available**  
See [crlaurence.co.uk](http://crlaurence.co.uk) for more information

## Colours

Chrome version shown below. 5 attractive colours available. For details please see the flip out chart at the rear of this brochure or visit [crlaurence.co.uk](http://crlaurence.co.uk)



View	Cat No. / Description	View	Cat No. / Description
	<b>PRIMA SENIOR</b> Cat. No. SRPPH01XX Top or Bottom Mount		<b>PRIMA JUNIOR</b> Cat. No. JRPPH01XX Top or Bottom Mount
	<b>PRIMA SENIOR</b> Cat. No. SRPPH02XX Glass-to-Glass Mount		<b>PRIMA JUNIOR</b> Cat. No. JRPPH02XX Glass-to-Fixed Transom Mount

## Flush Mount

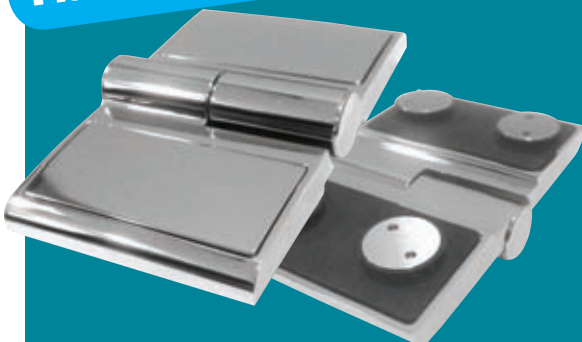

**Cat. No. R1V180LCH**  
180° Glass-to-Glass

**Cat. No. R1V180RCH**  
180° Glass-to-Glass

**Cat. No. R1V90LCH**  
90° Glass-to-Glass

**Matching Glass Clamps available see page 23**

## CRL Riviera Hinges

### Specifications

**Glass Thickness:** 8mm and 10mm Toughened Safety Glass

**Special Feature:** Flush mount in the inside of the panel and door. Door and fixed panel can adjust vertically up to 10mm.

**Hinge Swings:** Door opens outwards 170 degrees only

**Closing Type:** Self closing from 25° of closed position

**Cut-Out:** Required for fixed panel and door

**For maximum weight and door width capacities please see [crlaurence.co.uk](http://crlaurence.co.uk)**

### Colours

Chrome finish only



# CRL Serenity Series Sliding Door System



## Specifications

**Glass Thickness:** 8mm or 10mm Toughened Safety Glass

**Construction:** Stainless steel

**Maximum Door Weight:** Do not exceed either 762mm wide or 40kg

**Fabrication:** Holes required in both door and fixed panel (see [crlaurence.co.uk](http://crlaurence.co.uk))

## Colours

Polished Stainless (PS) shown below, also available in Brushed Stainless (BS). For details please see the flip out chart at the rear of this brochure or visit [crlaurence.co.uk](http://crlaurence.co.uk)



View

Cat No. / Description



### Cat. No. SERF2XX

#### Standard 180 Degree Kit Includes:

- 1 - 2m length header support bar
- 2 - Rollers
- 2 - Stoppers
- 2 - Anti-lift fittings
- 2 - Track holder fittings for wall
- 2 - Track holder fittings for fixed panel
- 1 - Thru-glass pull
- 1 - Door guide



### Cat. No. SER90XX

Accessory kit for 90 degree return  
Connects to wall fitting for 90 degree installations

90 degree  
return kit



# CRL Hydroslide Sliding Shower Door Kits



## Specifications

**Glass Thickness:** 8mm or 10mm Toughened Safety Glass

**Construction:** Plated or Lacquered Solid Brass Fittings; Anodised Aluminium Sliding Door Track

**Maximum Door Weight:** 40kg

**Includes:** Gaskets, Screws, and Glass Fabrication Information. Complete installation instructions along with glass and metal cutting formula available at [crlaurence.co.uk](http://crlaurence.co.uk)

## Colours

Chrome (CH) version shown below. 4 attractive colours available, Chrome (CH), Brass (BR), Brushed Nickel (BN), and Oil Rubbed Bronze (ORB). For details please see the flip out chart at the rear of this brochure or visit [crlaurence.co.uk](http://crlaurence.co.uk)



View

Cat No. / Description



**Cat. No. HYDK60XX** 180° Standard Kit 1524mm  
**Cat. No. HYDK84XX** 180° Standard Kit 2134mm

### 180° Standard Kit Consists of:

- |  |  |
|--|--|
| 1 - Sliding Glass Door Upper Track               | 2 - Hangers for Sliding Glass Door           |
| 2 - Sliding Glass Door Rollers                   | 2 - Sliding Glass Door Roller Stops          |
| 1 - Sliding Glass Door Floor Guide               | 2 - 90 Degree Wall-to-Upper Track Connectors |
| 1 - 914mm Half-Round SDT980 Threshold            | 1 - 2489mm DK98L L-Seal for wall             |
| 2 - 180 Degree Glass-to-Sliding Track Connectors |  |

NOTE: Bottom Fixed Glass Attachments, Handles or Knobs must be ordered separately.

### Cat. No. HYDA9XX

#### 90° Wall-to-Glass Accessory Kit Consists of:

- |  |                                     |
|--|-------------------------------------|
| 1 - 90 Degree Glass-to-Sliding Track Connector | 1 - 90 Degree Wall-to-Glass Bracket |
|--|-------------------------------------|

\*90 Degree Units require that you order one 180 Degree Standard Kit plus one 90 Degree Accessory Kit

# CRL Essence Series Sliding Shower Door System



## Specifications

**Glass Thickness Range:** 12mm toughened safety glass (Not included)

**Material:** Rollers and top guide, constructed of solid brass; bottom sliding track and U-Channel constructed of aluminium; clear plastic L-jamb

**Maximum Door Size:** Do not exceed either 787mm wide or 50.8 kg

**Basic Kit Fabrication:** Notch required for bottom rollers, holes required for top guide (see [crlaurence.co.uk](http://crlaurence.co.uk) for details)

## Colours

Chrome (CH) version shown below.  
4 attractive colours available, Chrome (CH), Brass (BR), Brushed Nickel (BN), and Oil Rubbed Bronze (ORB). For details please see the flip out chart at the rear of this brochure or visit [crlaurence.co.uk](http://crlaurence.co.uk)



View

Cat No. / Description



90 degree return kit available\*

**Cat. No. ESS1XX** Basic Essence Kit

**Basic ESS1 kit includes the following:**

- 2 - Bottom Rollers
- 1 - Top Door Guide
- 1 - 1.63m Length Bottom Track
- 1 - 2.49m Length U-Channel
- 1 - 2.49m Length Plastic L-Seal
- 1 - SDCEC12 End Cap for Channel
- 1 - M6164 Shower Door Bumper

NOTE: Glass Clamps, Handle or Knob, and Other Accessories Sold Separately.

\*90 Degree Units require that you order two each CL90S wall mount brackets, two each CL090 90 degree glass-to-glass brackets, and a basic ESS1 kit in your choice of finish.

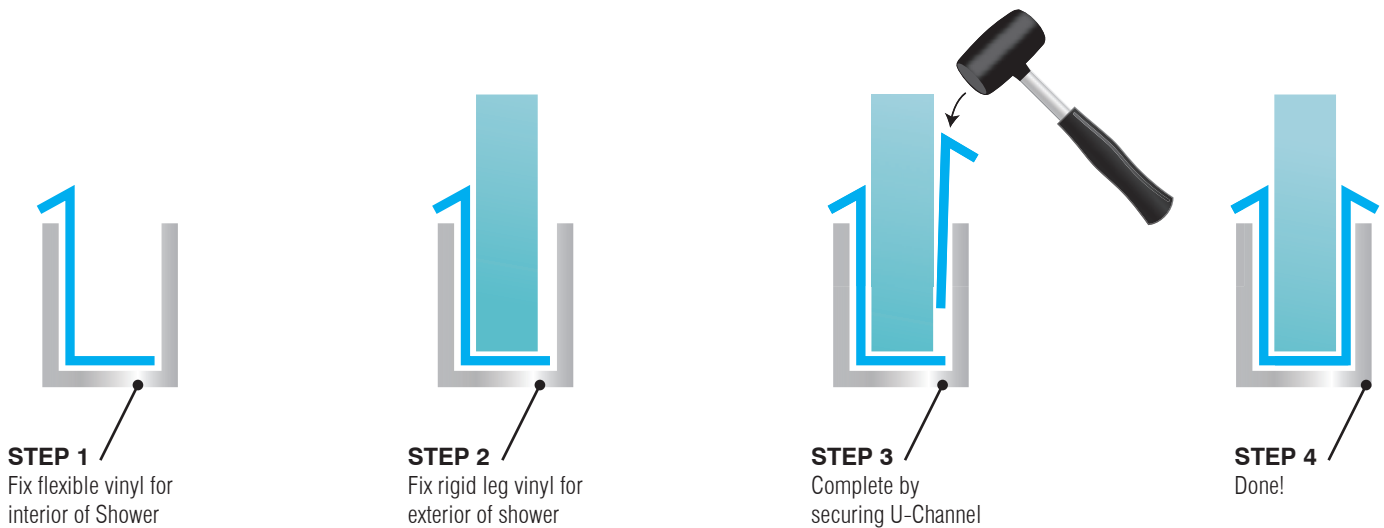

View	Features	Cat No. / Description
	<ul style="list-style-type: none"> <li>• Clear vinyl secures glass in channel and eliminate the need for messy silicone</li> <li>• Recess in bottom channel hides caulk line</li> <li>• Channel and matching end caps available in several popular finishes</li> </ul>	<p><b>Cat. No. DUC38XX</b> CRL Dry Glaze U-Channel for 10mm Glass only</p> <p><b>Cat. No. DUC516XX</b> CRL Dry Glaze U-Channel for 8mm Glass only</p>
	<ul style="list-style-type: none"> <li>• Extremely versatile extrusion in several popular finishes</li> <li>• Wet glazed with clear silicone to secure glass</li> <li>• Popular 2.49m lengths</li> <li>• Five popular finishes available</li> </ul>	<p><b>Cat. No. SDCD516XX</b> CRL Single U-Channel for 8mm Glass</p>
	<ul style="list-style-type: none"> <li>• Deep pocket for securing fixed panels of glass</li> <li>• May be used alone or with regular depth U-Channel</li> <li>• Wet glazed with clear silicone to secure glass</li> <li>• Popular 2.49m lengths</li> <li>• Visit <a href="http://crlaurence.co.uk">crlaurence.co.uk</a> for other available finishes and economical 3.66m stock lengths</li> </ul>	<p><b>Cat. No. SDCD38XX</b> CRL Deep U-Channel for 10mm Glass</p> <p><b>Cat. No. SDCD12XX</b> CRL Deep U-Channel for 12mm Glass</p>
	<ul style="list-style-type: none"> <li>• Covers Open End of SDCD38 Series U-Channels</li> <li>• Visit <a href="http://crlaurence.co.uk">crlaurence.co.uk</a> for other available finishes</li> </ul>	<p><b>Cat. No. SDCEC38XX</b> End Cap</p>
	<ul style="list-style-type: none"> <li>• Covers Open End of SDCD12 and DUC38 Series U-Channels</li> <li>• Visit <a href="http://crlaurence.co.uk">crlaurence.co.uk</a> for other available finishes</li> </ul>	<p><b>Cat. No. SDCEC12XX</b> End Cap</p>



# **Glass Clamps, Pull Handles & Knobs**



CRL Wall Mount Clamps mount directly to the wall, ceiling or floor to secure vertical fixed glass panels in contemporary shower enclosures. We also offer Glass-to-Glass Clamps that assist in maintaining the frameless appearance and provide a clean looking alternative to a U-Channel.

Our offering has evolved over the years to over 25 series of Glass Clamps in various configurations and beautiful finishes.

**CRL**<sup>®</sup>  
crlaurence.co.uk

# CRL Square Style Heavy-Duty Glass Clamps



## Specifications

**Glass Thickness:** 10mm to 12mm

**Construction:** Solid Brass

**Glass Fabrication Required:** SGCU1 requires notch; other clamps require holes or hole and notch combination

**Includes:** Mounting Screws and Gaskets

**Colours:** Chrome version shown below. 20 attractive colours available. For details please see the flip out chart at the rear of this brochure or visit [crlaurence.co.uk](http://crlaurence.co.uk)



View	Cat No. / Description	View	Cat No. / Description	View	Cat No. / Description
	<b>Cat. No. CAT. NO. SCU4XX</b> Square Wall Mount Clamp (Hole-in-Glass Style)  <b>Cat. No. CAT. NO. SCU48CH</b> For 8mm Glass Chrome finish only  Size: 51mm W x 51mm H		<b>Cat. No. SGC180XX</b> Square 180° Glass-to-Glass Clamp  Size: 127mm W x 51mm H		<b>Cat. No. SGC188XX</b> Square 180° Glass-to-Glass Movable Transom Clamp  Size: 103mm W x 51mm H
	<b>Cat. No. SGCU1XX</b> Square Wall Mount Clamp (Notch-in-Glass Style)  Size: 51mm W x 51mm H		<b>Cat. No. SGC135XX</b> Square 135° Glass-to-Glass Clamp  Each Leg Size: 64mm W x 51mm H		<b>Cat. No. SGCU1GXX</b> Replacement Gasket Notch Style
	<b>Cat. No. SGC037XX</b> Fixed Panel Square Clamp (with Small Leg)  Clamp Size: 51mm W x 51mm H Leg Size: 35mm W x 51mm H		<b>Cat. No. SGC90XX</b> Square 90° Glass-to-Glass Clamp  Each Leg Size: 64mm W x 51mm H		<b>Cat. No. SCU4GXX</b> Replacement Gasket Hole Style
	<b>Cat. No. SGC039XX</b> Fixed Panel Square Clamp (with Large Leg)  <b>Cat. No. SGC0398CH</b> For 8mm Glass Chrome finish only  Clamp Size: 51mm W x 51mm H Leg Size: 51mm W x 51mm H		<b>Cat. No. SGC186XX</b> Square Wall Mount Movable Transom Clamp  51mm W x 51mm H		

# CRL Bevelled Style Heavy-Duty Glass Clamps



## Specifications

**Glass Thickness:** 10mm to 12mm

**Construction:** Solid Brass

**Glass Fabrication Required:** BGCU1 requires notch; other clamps require holes or hole and notch combinations



**Includes:** Mounting Screws and Gaskets

**Colours:** Chrome version shown below. 20 attractive colours available. For details please see the flip out chart at the rear of this brochure or visit [crlaurence.co.uk](http://crlaurence.co.uk)



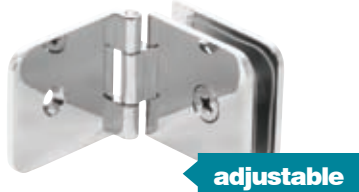

View	Cat No. / Description	View	Cat No. / Description	View	Cat No. / Description
	<p><b>Cat. No. BCU4XX</b> Square Wall Mount Clamp (Hole-in-Glass Style)</p> <p><b>Cat. No. BCU48CH</b> For 8mm Glass Chrome finish only</p> <p>Size: 51mm W x 51mm H</p>		<p><b>Cat. No. BGC180XX</b> Square 180° Glass-to-Glass Clamp</p> <p>Size: 127mm W x 51mm H</p>		<p><b>Cat. No. BGC188XX</b> Square 180° Glass-to-Glass Movable Transom Clamp</p> <p>Size: 103mm W x 51mm H</p>
	<p><b>Cat. No. BGC1XX</b> Square Wall Mount Clamp (Notch-in-Glass Style)</p> <p>Size: 51mm W x 51mm H</p>		<p><b>Cat. No. BGC135XX</b> Square 135° Glass-to-Glass Clamp</p> <p>Each Leg Size: 64mm W x 51mm H</p>		<p><b>Cat. No. BGC1GXX</b> Replacement Gasket Notch Style</p>
	<p><b>Cat. No. BGC037XX</b> Fixed Panel Square Clamp (with Small Leg)</p> <p><b>Cat. No. BGC0398CH</b> For 8mm Glass Chrome finish only</p> <p>Clamp Size: 51mm W x 51mm H</p> <p>Leg Size: 35mm W x 51mm</p>		<p><b>Cat. No. BGC90XX</b> Square 90° Glass-to-Glass Clamp</p> <p>Each Leg Size: 64mm W x 51mm H</p>		<p><b>Cat. No. BCU4GXX</b> Replacement Gasket Hole Style</p>
	<p><b>Cat. No. BGC039XX</b> Fixed Panel Square Clamp (with Large Leg)</p> <p>Clamp Size: 51mm W x 51mm H</p> <p>Leg Size: 51mm W x 51mm H</p>		<p><b>Cat. No. BGC186XX</b> Square Wall Mount Movable Transom Clamp</p> <p>51mm W x 51mm H</p>	<div style="background-color: #008080; color: white; padding: 5px; display: inline-block;"> <b>Flush Mount</b> </div> <p><b>CRL Riviera Hinge Glass Clamp</b></p> <p><b>Cat. No. R1V90CH</b> 90 degree Glass to Wall clamp with flush mount internal surface</p> <p>Clamp size: 67mm W x 79mm H</p> <p>Leg size: 84mm W x 79mm H</p> 	

# CRL Adjustable Glass Clamps

View	Rear View	Cat No. / Description
		<p><b>Cat. No. ADJ037XX</b> Adjustable Wall Mount Clamp</p> <p>Size: 49mm Wide x 44mm High</p> <p>Glass Thickness Range: 8mm to 12mm</p> <p>Hole Diameter Required: 22mm</p> <p>Includes: Clear Gaskets and Mounting Screw</p>
		<p><b>Cat. No. ADJ180XX</b> Adjustable Glass-to-Glass Mount Clamp</p> <p>Size: 49mm Wide (each leg) x 44mm High</p> <p>Glass Thickness Range: 8mm to 12mm</p> <p>Hole Diameter Required: 22mm</p> <p>Includes: Clear Gaskets and Mounting Screw</p>



## Glass Brackets to match Hinges

Front View	Cat No. / Description
	<p><b>To suit: Geneva, Concord, Vienna, Cardiff and Senior Cardiff Range</b></p> <p><b>Cat. No. GE090SXX</b> Glass-to-Glass Bracket</p> <p><b>Cat. No. GE90SXX</b> Wall Mount Bracket</p> <p>Matches configuration of the hinges listed above</p>
	<p><b>To suit: Pinnacle, Prima, Senior Prima, Cologne and Estate Range</b></p> <p><b>Cat. No. P1090XX</b> Glass-to-Glass Bracket</p> <p><b>Cat. No. P190SXX</b> Wall Mount Bracket</p> <p>Matches configuration of the hinges listed above</p>

**Colours:** Chrome version shown opposite. 14 attractive colours available.

For details please see the flip out chart at the rear of this brochure or visit [crlaurence.co.uk](http://crlaurence.co.uk)

Glass Thickness Range: 8 to 12mm  
Hole Diameter Required: 19mm







**Colours:** Chrome version shown opposite. 14 attractive colours available.

For details please see the flip out chart at the rear of this brochure or visit [crlaurence.co.uk](http://crlaurence.co.uk)

Glass Thickness Range: 8 to 12mm  
Hole Diameter Required: 19mm



## CRL Traditional Style Glass Clamps

View	Cat No. / Description	View	Cat No. / Description
	<p><b>Cat. No. UC77XX</b> Traditional Style Fixed Panel U-Clamp</p> <p>Glass Thickness Range: 8mm to 12mm</p> <p>Hole Diameter Required: 16 or 19mm</p> <p>Includes: Mounting Screws (for Wall Clamps) and Clear Gaskets</p> <p>*An additional set of clear gaskets (Cat. No. UCG77) is required for 8mm glass.</p>		<p><b>Cat. No. GCB90XX</b> 90 Degree Traditional Style Glass-to-Glass Clamp</p> <p>Glass Thickness Range: 8mm to 10mm</p> <p>Hole Diameter Required: 16 or 19mm</p> <p>Includes: Gaskets and Wood Screw for wall mount application.</p> <p>*An additional set of gaskets is required for 8mm glass (Cat. No. UCG77)</p>
	<p><b>Cat. No. GCB184XX</b> 180 Degree Traditional Style Double Stud Glass-to-Glass Clamp</p> <p>Glass Thickness Range: 8mm to 12mm</p> <p>Hole Diameter Required: 16 or 19mm</p> <p>Includes: Gaskets.</p> <p>*An additional set of gaskets is required for 8mm glass (Cat. No. GCBG184).</p>		<p><b>Cat. No. GCB182XX</b> 180 Degree Traditional Style Split Face and "Y" Inline Glass-to-Glass Clamp</p> <p>Glass Thickness Range: 8mm to 12mm</p> <p>Hole Diameter Required: 16 or 19mm</p> <p>Includes: Gaskets, Screw for "Y" Inline Clamp use.</p> <p>*An additional set of gaskets is required for 8mm glass (Cat. No. UCG77).</p>



# CRL Pull Handles and Knobs

**View**

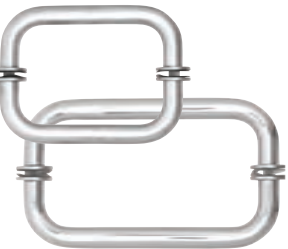

**Cat No. / Description**

**BM Series Back-to-Back Pull Handles**

**Cat. No. BM6X6XX**  
152mm size with metal washers

**Cat. No. BM8X8XX**  
203mm size with metal washers

Material: 19mm Diameter Brass Tubing (1.5mm thick), 31.8mm Diameter Washers

Glass Thickness Range: 6mm to 12mm

Hole Diameter Required: 12mm

Centre-to-Centre Hole: 152mm; 203mm

**BM Series Back-to-Back Pull Handles**

**Cat. No. BMN6X6XX**  
152mm size without metal washers

**Cat. No. BMN8X8XX**  
203mm size without metal washers

Material: 19mm Diameter Brass Tubing (1.5mm thick)

Glass Thickness Range: 6mm to 12mm

Hole Diameter Required: 12mm

Centre-to-Centre Hole: 152mm; 203mm

**Crescent Style Back-to-Back Pull Handles**

**Cat. No. CSH6X6XX** 152mm

**Cat. No. CSH8X8XX** 203mm

Material: 19mm Brass Tubing

Glass Thickness Range: 6mm to 12mm

Hole Diameter Required: 12mm

Centre-to-Centre Hole: 152mm; 203mm

**SQ Series Square Tubing Mitred Corner Back-to-Back Pull Handles**

**Cat. No. SQ6X6XX** 152mm

**Cat. No. SQ8X8XX** 203mm

Material: 19mm Brass Tubing

Glass Thickness Range: 6mm to 12mm

Hole Diameter Required: 12mm

Centre-to-Centre Hole: 152mm, 203mm

**MT Series Round Tubing Mitred Corner Back-to-Back Pull Handles**

**Cat. No. MT6X6XX** 152mm

**Cat. No. MT8X8XX** 203mm

Material: 19mm Brass Tubing; 31.75mm Metal Washers

Glass Thickness Range: 6mm to 12mm

Hole Diameter Required: 12mm

Centre-to-Centre Hole: 152mm, 203mm

**RM Series Flat Outside Surface/Round Tubing Inside Back-to-Back Pull Handles**

**Cat. No. RM6X6XX** 152mm

**Cat. No. RM8X8XX** 203mm

Material: 19mm Brass Tubing

Glass Thickness Range: 6mm to 12mm

Hole Diameter Required: 12mm

Centre-to-Centre Hole: 152mm, 203mm

**View**



**Cat No. / Description**

**CRL SDK Series Knobs**

**Cat. No. SDK106XX**  
30mm Round Knob Set

Material: Solid Brass Material

Glass Thickness Range: Fits 6 to 12mm Thick Glass

Available in Several Attractive Finishes

Hole  $\varnothing$  10 or 12mm

**CRL SDK Series Knobs**

**Cat. No. SDK160XX**  
30mm Square Knob Set

Material: Solid Brass Material

Glass Thickness Range: Fits 6 to 12mm Thick Glass

Available in Several Attractive Finishes

Hole  $\varnothing$  12mm

**CRL SDK Series Knobs**

**Cat. No. SDK140XX**  
25mm Round Knob Set

Material: Solid Brass Material

Glass Thickness Range: Fits 6 to 12mm Thick Glass

Available in Several Attractive Finishes

Hole  $\varnothing$  10 or 12mm

**CRL SDK Series Knobs**

**Cat. No. SDK112XX**  
19mm Square Knob Set without Plastic Sleeve

**Cat. No. SDKP112XX**  
19mm Square Knob Set with Plastic Sleeve

Material: Solid Brass Material

Glass Thickness Range: Fits 6 to 12mm Thick Glass

Available in Several Attractive Finishes

Hole  $\varnothing$  10 or 12mm

**CRL Chrome Back-to-Back Bow-Tie Style Knobs**

**Cat. No. SDK109XX**  
Back-to-Back Knob

Solid Brass Material

Fits 6 to 12mm Thick Glass

Available in Several Beautiful Finishes

Hole  $\varnothing$  10 or 12mm

**Cat. No. LP6X6XX**  
152mm Handle

**Cat. No. LP8X8XX**  
203mm Handle

**Mounting Holes / Centre-to-centre**  
152mm / 203mm

Material: 19mm Brass Tubing 152 and 203mm Sizes  
32mm Brass Tubing All Other

Glass Thickness Range: 8mm to 12mm

Hole Diameter Required: For 152 and 203mm  
Handles: 12mm



A modern bathroom with a bathtub, a glass shower enclosure, and a towel bar. The scene is dimly lit, with a teal square graphic element on the left side.

# Support & Towel Bars



Our range of Support Bars comes in a variety of lengths and finishes, suitable for different glass thicknesses, to enable you to create your perfect bathroom space.

Our range of Towel Bars will add a touch of elegance and class to your bathroom. Constructed of tubular brass, CRL's Towel Bars ensure your door installations will last for a long time as their lightweight properties help to keep the weight of the door hardware to a minimum.

All CRL Frameless Shower Door Hardware has consistent finishes and will instantly add a look of quality to the appearance of your enclosure, and with proper care and cleaning, will remain beautiful for years to come.

**CRL**<sup>®</sup>  
crlaurence.co.uk

## Thru-Glass to Wall Rod

View	Specification	Cat No. / Description
 <p><b>Ideal for use as a Shower Curtain Rod</b></p>	<p>Material: 19mm Diameter Stainless Steel Tubing</p> <p>Bar Lengths: 1.83m</p> <p>Glass Thickness Range: 6 to 12mm</p> <p>Glass Fabrication Required: 12mm Diameter Hole</p> <p>Includes: 19mm Diameter End Cap on One End</p> <p>Polished Stainless (PS) shown, also available in Brushed Stainless (BS). For details please see the flip out chart at the rear of this brochure or visit <a href="http://crlaurence.co.uk">crlaurence.co.uk</a></p>	<p><b>Cat. No. TUBE3472XX</b> Thru-Glass to Wall Rod</p> <p>Requires additional fitting for wall attachment i.e. S3 or S12</p>

## Through-Glass Mounted Support Bar

The Through-Glass Mounted Support Bar creates a means of support that strengthens an enclosure's structural integrity. It may be used in place of a header in certain applications (call for details) and can be mounted to a wall, ceiling or glass-to-glass. Supplied Bar is 991mm long, requires a 16mm hole in the glass, and comes in finishes to match our Hinges and Pull Handles. All mounting hardware included.

View	Specification	Cat No. / Description
	<p>Choice of wall/ceiling mount or glass-to-glass mount</p> <p>Helps strengthen structural integrity of shower enclosure</p> <p>Stocked in numerous finishes, with custom finishes available</p> <p>991mm bar length, 1.08M overall length</p> <p>All mounting hardware included</p>	<p><b>Cat. No. SUP135XX</b> Wall Mount</p> <p><b>Cat. No. SUP135G2GXX</b> Glass-to-Glass Mount</p> <p>16mm ø hole required</p>



## Mitred Support Bar Bracket

The Mitred Support Bar Wall Mount Bracket is designed to attach to the wall by slipping over a screw mounted stud that is secured into the wall. Perfect for an inline panel needing to be secured to an adjacent wall for stability. The Bracket comes in matching finishes, and fits any of our Fixed Panel Support Bars. Mitre of Bracket ensures flush fit against wall.

View	Specification	Cat No. / Description
 <p><b>Cat. No. SBB45</b> 45° Bracket</p> <p><b>Cat. No. SBB22</b> 22.5° Bracket</p>	<p>A great solution for inline enclosures requiring fixed panel support when a header is not desired</p> <p>Can replace a fitting on the end of a stock support bar</p> <p>Attaches to wall easily via a screw-mounted stud</p> <p>Available in many popular finishes</p>	<p><b>Cat. No. SBB45XX</b> 45° Bracket</p> <p><b>Cat. No. SBB22XX</b> 22.5° Bracket</p>





These Fixed Panel Support Bars stabilize fixed panels of glass in enclosures that do not go all the way up to the ceiling. Bars are available in two lengths, and in sizes to secure 6mm to 12mm thick glass. Finishes are available to match most of our hinges, knobs, and pull handles. No holes or cut-outs are required in the glass.

View	Specification	Cat No. / Description
 <p><b>Glass-to-Glass</b></p>	<p>Material: 19mm Diameter Tubular Brass Bar, Solid Brass Fittings</p> <p>Colours: Chrome version shown opposite. 20 attractive colours available. For details please see the flip out chart at the rear of this brochure or visit <a href="http://crlaurence.co.uk">crlaurence.co.uk</a></p> <p>Bar Lengths: 1m; 1.3m</p> <p>Glass Thickness Range: 6mm to 8mm, and 10mm to 12mm</p> <p>Includes: All Required Mounting Hardware</p>	<p><b>Cat. No. SUP26XX</b> Glass-to-Glass Model Support Bar for 6mm to 8mm glass Length: 1m</p> <p><b>Cat. No. SUP20XX</b> Glass-to-Glass Model Support Bar for 10mm to 12mm glass Length: 1m</p> <p><b>Cat. No. SUP20XX51</b> Glass-to-Glass Model Support Bar for 10mm to 12mm glass Length: 1.3m</p>
 <p><b>Wall-to-Glass</b></p>	<p>Material: 19mm Diameter Tubular Brass Bar, Solid Brass Fittings</p> <p>Colours: Chrome version shown opposite. 20 attractive colours available. For details please see the flip out chart at the rear of this brochure or visit <a href="http://crlaurence.co.uk">crlaurence.co.uk</a></p> <p>Available Bar Lengths: 1m; 1.3m</p> <p>Glass Thickness Range: 6mm to 8mm, and 10mm to 12mm</p> <p>Includes: All Required Mounting Hardware</p>	<p><b>Cat. No. SUP06XX</b> Wall-to-Glass Model Support Bar for 6mm to 8mm glass Length: 1m</p> <p><b>Cat. No. SUP10XX</b> Wall-to-Glass Model Support Bar for 10mm to 12mm glass Length: 1m</p> <p><b>Cat. No. SUP10XX51</b> Glass-to-Glass Model Support Bar for 10mm to 12mm glass Length: 1.3m</p>

View	Cat No. / Description
	<p><b>Cat. No. S3XX</b> Wall Mount Fitting</p> <p>Chrome version shown opposite. 19 attractive colours available. For details please see the flip out chart at the rear of this brochure or visit <a href="http://crlaurence.co.uk">crlaurence.co.uk</a></p>
	<p><b>Cat. No. S4XX</b> Swiveling U-Bracket for 6mm and 8mm Glass</p> <p><b>Cat. No. S5XX</b> Swiveling U-Bracket for 10mm and 12mm Glass</p> <p>Chrome version shown opposite. 19 attractive colours available. For details please see the flip out chart at the rear of this brochure or visit <a href="http://crlaurence.co.uk">crlaurence.co.uk</a></p>
	<p><b>Cat. No. S6XX</b> Movable Bracket for 6mm Glass</p> <p><b>Cat. No. S7XX</b> Movable Bracket for 10mm Glass</p> <p>Chrome version shown opposite. 19 attractive colours available. For details please see the flip out chart at the rear of this brochure or visit <a href="http://crlaurence.co.uk">crlaurence.co.uk</a></p>
	<p><b>Cat. No. S8XX</b> 90° Corner Bracket for Support Bars</p> <p>Chrome version shown opposite. 19 attractive colours available. For details please see the flip out chart at the rear of this brochure or visit <a href="http://crlaurence.co.uk">crlaurence.co.uk</a></p>

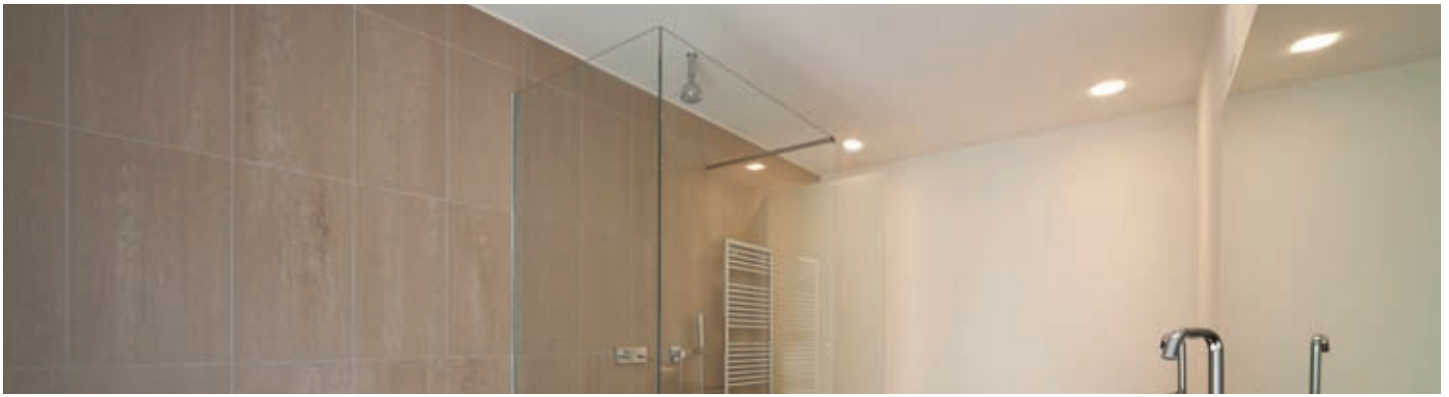
View	Cat No. / Description
	<p><b>Cat. No. S9XX</b> Vertical Support Bracket for 6mm to 8mm Glass</p> <p><b>Cat. No. S91XX</b> For 10mm to 12mm Glass</p> <p>Chrome version shown opposite. 19 attractive colours available. For details please see the flip out chart at the rear of this brochure or visit <a href="http://crlaurence.co.uk">crlaurence.co.uk</a></p>
	<p><b>Cat. No. S12XX</b> Slim Line Wall Mount Fitting</p> <p>Chrome version shown opposite. 19 attractive colours available. For details please see the flip out chart at the rear of this brochure or visit <a href="http://crlaurence.co.uk">crlaurence.co.uk</a></p>
	<p><b>Cat. No. S13XX</b> Slim Line Glass Mount Fitting for 6mm to 12mm Glass</p> <p>Chrome version shown opposite. 19 attractive colours available. For details please see the flip out chart at the rear of this brochure or visit <a href="http://crlaurence.co.uk">crlaurence.co.uk</a></p>
	<p><b>Cat. No. S1XX</b> 1m Bar Only</p> <p><b>Cat. No. S2XX</b> 1.3m Bar Only</p> <p><b>Cat. No. S80</b> 2.03m Bar Only</p> <p>Material: 19mm Diameter Tubular Brass Bar. Available Bar Lengths: 1m; 1.3m; 2.03m.</p> <p>Chrome version shown opposite. 19 attractive colours available.</p>



View	Specification	Cat No. / Description
	<p>Material: 19mm square tubing, solid brass fittings</p> <p>Chrome version shown. 5 attractive colours available. For details please see the flip out chart at the rear of this brochure or visit <a href="http://crlaurence.co.uk">crlaurence.co.uk</a></p> <p>Bar Lengths: 1.5m</p> <p>New square tubing matches geometry of many popular CRL hinges</p> <p>Provides fixed panel support for enclosures not going to the ceiling</p> <p>No hole drilling required in glass</p>	<p><b>Cat. No. SQ59XX</b> 1.5m Square Bar</p>

View	Cat No. / Description
	<p><b>Cat. No. SQ41XX</b> Swiveling U-Bracket for 6 to 8mm Glass for Square Bar</p> <p><b>Cat. No. SQ42XX</b> Swiveling U-Bracket for 10 to 12mm Glass for Square Bar</p>
	<p><b>Cat. No. SQ43XX</b> Movable Bracket for 6 to 8mm Glass for Square Bar</p>
	<p><b>Cat. No. SQ44XX</b> Movable Bracket for 10 to 12mm Glass for Square Bar</p>
	<p><b>Cat. No. SQ45XX</b> Adjustable Corner Bracket for Square Bar</p>
	<p><b>Cat. No. SQ46XX</b> Wall Mount Bracket for Square Bar</p>

View	Cat No. / Description
	<p><b>Cat. No. SQ47XX</b> 45° Mitred Wall Mount Bracket for Square Bar</p>
	<p><b>Cat. No. SQ48XX</b> 22.5° Mitred Wall Mount Bracket for Square Bar</p>
	<p><b>Cat. No. SQ49XX</b> Adjustable Wall Mount Bracket for Square Bar</p>
	<p><b>Cat. No. SQ50XX</b> "T" Junction Bracket for Square Bar</p>

# CRL EZ-Adjust Shower Door Header Kit



## Features

- Secures shower enclosure not going to ceiling
- Allows horizontal (side-to-side) adjustment of hinge after installation
- No hole drilling required through header for adaptor, if using Prima Hinge model PPH06 or Senior Prima Hinge model SRPPH06
- Constructed of heavy 6063-T5 aluminium alloy
- For use with 8mm, 10mm and 12mm thick glass

## Colours

Chrome version shown. 8 attractive colours available. For details please see the flip out chart at the rear of this brochure or visit [crlaurence.co.uk](http://crlaurence.co.uk)



View	Specification	Cat No. / Description
------	---------------	-----------------------

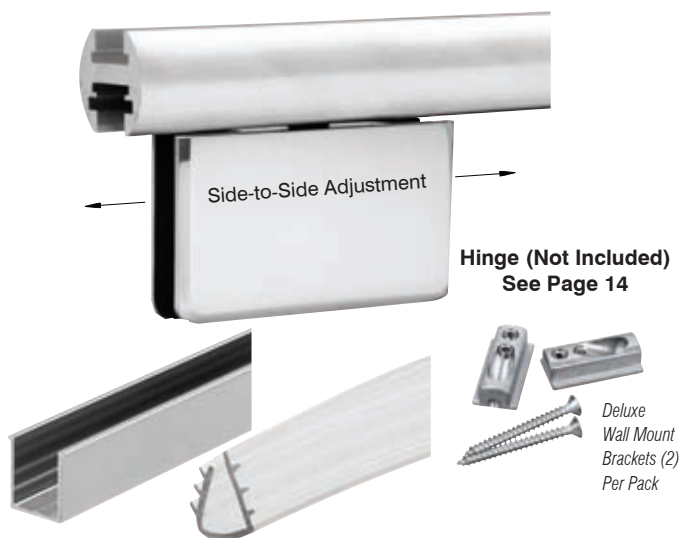

## Each Kit Contains

- 1 – 2.49m or 3.6m Header Length
- 1 – 914mm Snap-In Filler Insert for Door Pocket
- 1 – Deluxe Wall Mount Bracket Kit (Two Brackets)
- 2.44m or 3.65m of 8mm and 10mm Clear Vinyl

Vinyl not required for 12mm Glass

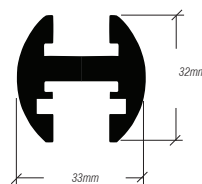

## Cat. No. EHK98XX

2.49m EZ-Adjust Shower Door Header Kit

## Cat. No. EHK144XX

3.65m EZ-Adjust Shower Door Header Kit

If using Prima Hinge Model PPH06 or Senior Prima Hinge Model SRPPH06, hinge can be adjusted side-to-side after installation. No drilling required to install hinge into header if using those hinges.

## CRL Deluxe Shower Door Header Kit



## Each Kit Contains

- 1.67m, 2.49m or 3.65m Piece of Header Extrusion
- .91m Piece of Snap-In Filler for Door Pocket
- Vinyl for 8mm and 10mm Glass (not needed for 12mm)
- Pack of two SHB100 Aluminium Wall Mounting Brackets and pack of two BWB2 Brass Wall Mounting Brackets (use set of your choice)

## SDH Series Flat/Round Profile

Cat. No. SDH660XX  
1.67m Deluxe Header Kit

Cat. No. SDH980XX  
2.49m Deluxe Header Kit

Cat. No. SDH144XX  
3.65m Deluxe Header Kit

## SQH Series Flat/Flat Profile

Cat. No. SQH980XX  
2.49m Deluxe Header Kit

# CRL Frameless Vertical Post System



## Specifications

- Stock or custom kits allow user to stabilise fixed panels of glass not going to ceiling
- Excellent alternative to traditional horizontal header systems
- Four popular stock finishes for 8, 10, and 12mm glass
- Glass fabrication required for tube adaptors/ end caps with 19mm holes
- Custom kits available in various finishes, post configurations, and with dome or ball style glue-in end caps (Two-Point System only)



## Cat No. / Description

### Cat. No. VPK33XX

#### Two Point Ceiling Mount System Kit

- 1 Each - 838mm length of 51mm diameter Round Tubing, two Rivet Nuts, and Flat Style End Cap
- 2 Each - Tube Adaptors with 38mm diameter End Caps (with Threaded Stud)
- 1 Each - Removable Top Flange with Set Screw

**NOTE:** There are size limitations when hinging a door off a panel fastened using the VPK33. Call our Frameless Shower Department for details.

## Cat No. / Description

### Cat. No. VPK92XX

#### Floor to Ceiling Mount System Kit

- 1 Each - 2300mm length of 51mm diameter Round Tubing, with welded Bottom Flange and two Rivet Nuts
- 2 Each - Tube Adaptors with 38mm diameter End Caps (with Threaded Stud)
- 1 Each - Removable Top Flange with Set Screw

**NOTE:** Stock Kit is prepared for one degree floor slope to the inside of the shower. Shimming is required if floor is not a one degree slope to the inside of the shower, or a Custom Kit may be ordered instead.



# CRL Glass Door Locks with Indicator

## Swinging Door Application

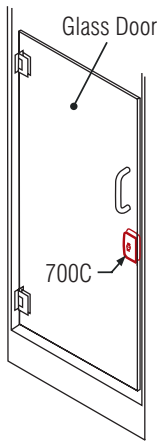

Lock on Single Door Glass-to-Wall

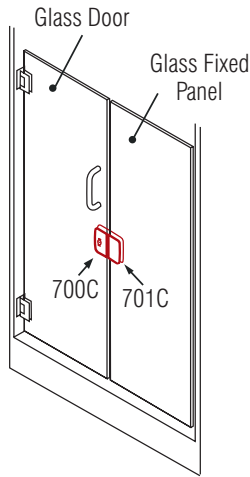

Lock and Receiver on Double Doors Glass-to-Glass

## Sliding Door Application

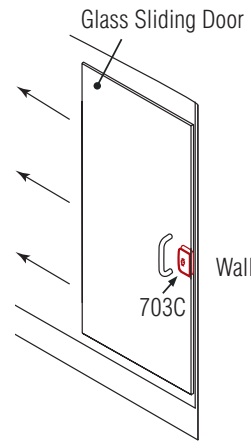

Lock on Single Glass-to-Wall Door

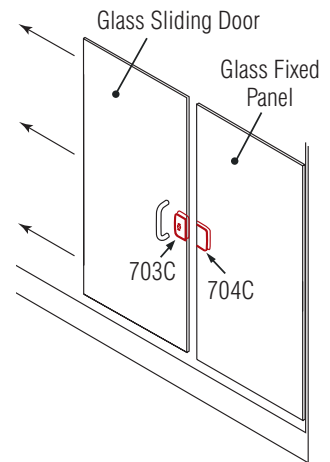

Lock and Keeper on Glass-to-Glass Doors



Exterior View	Interior View	Cat No. / Description	Features
		<b>Cat. No. 700CXX</b> Sliding Door Lock	<ul style="list-style-type: none"> <li>• Choice of Swinging Door and Sliding Door Models</li> <li>• Lock Can Be Used Glass-to-Wall, or Glass-to-Glass With Optional Matching Receiver</li> <li>• Available in Up to Five Popular Finishes: Chrome, Brass, Antique Brass, Brushed Nickel, and Oil Rubbed Bronze</li> </ul>
		<b>Cat. No. 701CXX</b> Sliding Door Receiver	
		<b>Cat. No. 703CXX</b> Sliding Door Lock	
		<b>Cat. No. 704CXX</b> Sliding Door Receiver	







# CRL Towel Bars

Material: 19mm Diameter Brass Tubing (1.5mm thick); 31.8mm Diameter Metal Washers

Glass Thickness Range: 6mm to 12mm

Hole Diameter Required: 12mm



View	Cat No. / Description	Centre-to-Centre Hole
	<b>Cat. No. BM12XX</b>	305mm Towel Bar
	<b>Cat. No. BM18XX</b>	457mm Towel Bar
	<b>Cat. No. BM20XX</b>	508mm Towel Bar
	<b>Cat. No. BM22XX</b>	559mm Towel Bar
	<b>Cat. No. BM24XX</b>	610mm Towel Bar
	<b>Cat. No. BM26XX</b>	660mm Towel Bar
	<b>Cat. No. BM27XX</b>	686mm Towel Bar
	<b>Cat. No. BM28XX</b>	711mm Towel Bar
	<b>Cat. No. BM30XX</b>	762mm Towel Bar
	<b>Cat. No. BMNW12XX</b>	305mm Towel Bar
	<b>Cat. No. BMNW18XX</b>	457mm Towel Bar
	<b>Cat. No. BMNW20XX</b>	508mm Towel Bar
	<b>Cat. No. BMNW22XX</b>	559mm Towel Bar
	<b>Cat. No. BMNW24XX</b>	610mm Towel Bar
	<b>Cat. No. BMNW26XX</b>	660mm Towel Bar
	<b>Cat. No. BMNW27XX</b>	686mm Towel Bar
	<b>Cat. No. BMNW28XX</b>	711mm Towel Bar
	<b>Cat. No. BMNW30XX</b>	762mm Towel Bar
	<b>Cat. No. CSH18XX</b>	457mm Towel Bar
	<b>Cat. No. CSH24XX</b>	610mm Towel Bar
	<b>Cat. No. SQ18XX</b>	457mm Towel Bar
	<b>Cat. No. SQ24XX</b>	610mm Towel Bar
	<b>Cat. No. MT18XX</b>	457mm Towel Bar
	<b>Cat. No. MT24XX</b>	610mm Towel Bar
	<b>Cat. No. BM12X12XX</b>	305mm Towel Bar
	<b>Cat. No. BM18X18XX</b>	457mm Towel Bar
	<b>Cat. No. BM24X24XX</b>	610mm Towel Bar
	<b>Cat. No. BM30X30XX</b>	762mm Towel Bar





# CRL Towel Bars

Material: 19mm Diameter Brass Tubing (1.5mm thick); 31.8mm Diameter Metal Washers

Glass Thickness Range: 6mm to 12mm













Hole Diameter Required: 12mm



View	Cat No. / Description	Centre-to-Centre Hole
	Cat. No. <b>BMNW12X12XX</b>	305mm Towel Bar
	Cat. No. <b>BMNW18X18XX</b>	457mm Towel Bar
	Cat. No. <b>BMNW24X24XX</b>	610mm Towel Bar
	Cat. No. <b>BMNW30X30XX</b>	762mm Towel Bar
	Cat. No. <b>CSH18X18XX</b>	457mm Towel Bar
	Cat. No. <b>CSH24X24XX</b>	610mm Towel Bar
	Cat. No. <b>SQ18X18XX</b>	457mm Towel Bar
	Cat. No. <b>SQ24X24XX</b>	610mm Towel Bar
	Cat. No. <b>MT18X18XX</b>	457mm Towel Bar
	Cat. No. <b>MT24X24XX</b>	610mm Towel Bar
 <p><b>Pull Handle/ Towel Bar Combination</b></p>	Cat. No. <b>BM6X12XX</b>	152mm Pull / 305mm Towel Bar
	Cat. No. <b>BM6X18XX</b>	152mm Pull / 457mm Towel Bar
	Cat. No. <b>BM6X22XX</b>	152mm Pull / 559mm Towel Bar
	Cat. No. <b>BM6X24XX</b>	152mm Pull / 610mm Towel Bar
	Cat. No. <b>BM8X18XX</b>	203mm Pull / 457mm Towel Bar
	Cat. No. <b>BM8X20XX</b>	203mm Pull / 508mm Towel Bar
	Cat. No. <b>BM8X22XX</b>	203mm Pull / 457mm Towel Bar
	Cat. No. <b>BM8X24XX</b>	203mm Pull / 610mm Towel Bar
 <p><b>Pull Handle/ Towel Bar Combination</b></p>	Cat. No. <b>BMNW6X12XX</b>	152mm Pull / 305mm Towel Bar
	Cat. No. <b>BMNW6X18XX</b>	152mm Pull / 457mm Towel Bar
	Cat. No. <b>BMNW6X22XX</b>	152mm Pull / 559mm Towel Bar
	Cat. No. <b>BMNW6X24XX</b>	152mm Pull / 610mm Towel Bar
	Cat. No. <b>BMNW8X18XX</b>	203mm Pull / 457mm Towel Bar
	Cat. No. <b>BMNW8X22XX</b>	203mm Pull / 457mm Towel Bar
	Cat. No. <b>BMNW8X24XX</b>	203mm Pull / 610mm Towel Bar
	Cat. No. <b>BMNW12X24XX</b>	305mm Pull / 610mm Towel Bar

# CRL Shower Door Seals



View	Features	Cat. No. / Description
 	<ul style="list-style-type: none"> <li>• Can be used on inswing and outswing doors</li> <li>• 2.49m stock length</li> </ul>	<p><b>Cat. No. PCR8</b> CRL Translucent Vinyl Bulb Seal</p>
 	<ul style="list-style-type: none"> <li>• Can be used on inswing and outswing doors</li> <li>• 2.49m stock length</li> </ul>	<p><b>Cat. No. PCR10</b> CRL Translucent Vinyl Bulb Seal</p>
 	<ul style="list-style-type: none"> <li>• Can be used as bottom sweep, or vertically on bi-fold doors</li> <li>• 2.49m stock length</li> <li>• Snap on application</li> <li>• Can be used two ways</li> </ul>	<p><b>Cat. No. P14WS</b> CRL Dual Durometer PVC Seal and Wipe</p>
 	<ul style="list-style-type: none"> <li>• Can be used as bottom sweep, or vertically on bi-fold doors</li> <li>• 2.49m stock length</li> <li>• Snap on application</li> <li>• Can be used two ways</li> </ul>	<p><b>Cat. No. P770WS</b> CRL Dual Durometer PVC Seal and Wipe</p>
 	<ul style="list-style-type: none"> <li>• Can be used as bottom sweep, or vertically on bi-fold doors</li> <li>• 2.49m stock length</li> <li>• Snap on application</li> <li>• Can be used two ways</li> </ul>	<p><b>Cat. No. P880WS</b> CRL Dual Durometer PVC Seal and Wipe</p>
 	<ul style="list-style-type: none"> <li>• Can be used as bottom sweep, or vertically on bi-fold doors</li> <li>• 2.49m stock length</li> <li>• Snap on application</li> <li>• Can be used two ways</li> </ul>	<p><b>Cat. No. P120WS</b> CRL Dual Durometer PVC Seal and Wipe</p>



# CRL Shower Door Seals

View	Features	Glass Thickness	'X'	'Y'	Cat No. / Description
		6mm	16mm	-	<b>Cat. No. P914WS</b> CRL Co-Extruded Bottom Wipe With Drip Rail
		8mm	16mm	-	<b>Cat. No. P956WS</b> CRL Co-Extruded Bottom Wipe With Drip Rail
		10mm	19mm	-	<b>Cat. No. P990WS</b> CRL Co-Extruded Bottom Wipe With Drip Rail
		12mm	19mm	-	<b>Cat. No. P912WS</b> CRL Co-Extruded Bottom Wipe With Drip Rail
		8mm	10mm	-	<b>Cat. No. P450BR</b> CRL Clear Bottom Rail With Translucent Wipe
		10mm	11mm	-	<b>Cat. No. P500BR</b> CRL Clear Bottom Rail With Translucent Wipe
		12mm	12mm	-	<b>Cat. No. P660BR</b> CRL Clear Bottom Rail With Translucent Wipe
		8mm	19mm	11mm	<b>Cat. No. PCC8</b> CRL "H" Jamb With Soft Leg
		10mm	21mm	12mm	<b>Cat. No. PCC10</b> CRL "H" Jamb With Soft Leg
		12mm	21mm	12mm	<b>Cat. No. PCC12</b> CRL "H" Jamb With Soft Leg
View	Features	Cat No. / Description			
		<ul style="list-style-type: none"> <li>• Can be used on inswing and outswing doors</li> <li>• Close Gaps from 1.6 to 5mm</li> <li>• 2.49m stock length</li> <li>• Adheres using silicone only (not very hi-bond tape)</li> </ul>	<b>Cat. No. S1LB</b> CRL Translucent Silicone Bulb Seal		
		<ul style="list-style-type: none"> <li>• Pre-applied VHB tape for easy installation</li> <li>• Labour savings due to pre-application of tape</li> <li>• Stocked in 2.49m lengths</li> </ul>	<b>Cat. No. SDTJT2</b> CRL SDTB with Pre-Applied Tape		
		<ul style="list-style-type: none"> <li>• Pre-applied tape for easy installation</li> <li>• Labour savings due to pre-application of tape</li> <li>• Stocked in 2.49m lengths</li> </ul>	<b>Cat. No. SDTBT2</b> CRL Deep U-Channel for 10mm Glass		
		<ul style="list-style-type: none"> <li>• Pre-applied VHB tape for easy installation</li> <li>• Labour savings due to pre-application of tape</li> <li>• Stocked in 2.49m lengths</li> </ul>	<b>Cat. No. SDTDFT2</b> CRL SDTDF with Pre-Applied Tape		
		<ul style="list-style-type: none"> <li>• Pre-applied tape for easy installation</li> <li>• Labour savings due to pre-application of tape</li> <li>• Stocked in 2.49m lengths</li> </ul>	<b>Cat. No. SDTNLT2</b> CRL SDTNL with Pre-Applied Tape		
		<ul style="list-style-type: none"> <li>• Pre-applied high-bond tape for easy installation</li> <li>• Labour savings due to pre-application of tape</li> <li>• Stocked in 2.49m lengths</li> </ul>	<b>Cat. No. SDTLT2</b> CRL SDTL with Pre-Applied Tape		
		<ul style="list-style-type: none"> <li>• Pre-applied high-bond tape for easy installation</li> <li>• Labour savings due to pre-application of tape</li> <li>• Stocked in 2.49m lengths</li> </ul>	<b>Cat. No. SDTST2</b> CRL SDTS with Pre-Applied Tape		
		<ul style="list-style-type: none"> <li>• Pre-applied tape for easy installation</li> <li>• Labour savings due to pre-application of tape</li> <li>• Stocked in 2.49m lengths</li> </ul>	<b>Cat. No. SDTWT2</b> CRL SDTW with Pre-Applied Tape		

# Create the perfect bathroom

with CRL's huge range of Shower Hardware and accessories, from installation to maintenance.



View      Cat. No. / Description      View      Cat. No. / Description



**Cat. No. EB1701**  
CRL Spray Glass Cleaner

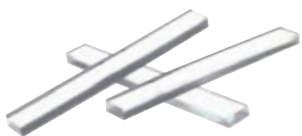

**Cat. No. PSB040**  
CRL Clear Plastic Setting Blocks



**Cat. No. EWCW1**  
CRL Cleret Elite Squeegee



**Cat. No. 16351**  
CRL E-Z Mount Mirror Clip Sets

View Cat No. / Description



**Cat. No. NDC4XX**  
No-Drill Fixed Panel Clamp



**Cat. No. 31M8010XX**  
180° Wall Mount Hinge  
Hold Open  
Hydraulic Self -Close



**Cat. No. 31M8015XX**  
180° Glass-To-Glass Hinge  
Hold Open  
Hydraulic Self -Close

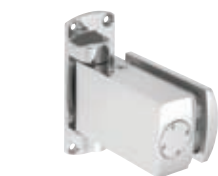

**Cat. No. 31M8060XX**  
One Way Swinging Wall Mount Hinge  
Hold Open  
Hydraulic Self -Close

**Ideal for saunas  
and steam rooms**

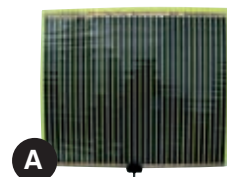

**Cat. No. 7020MP - 7050MP**  
CRL Heated Mirror Pads



**Cat. No. D645BA**  
CRL Brite Anodised Nose Aluminum "J" Channel



**Cat. No. 1631A**  
CRL Chrome Plated Dome Head No 8 Gauge Steel Screws



**Cat. No. DL631XX**  
CRL Adjustable Shelf Brackets



**Cat. No. PC6100**  
CRL 6K Surface Protector - Pre Clean 1 litre  
**Cat. No. NS6100**  
CRL 6K Surface Protector - Protect 1 litre

View Cat No. / Description



**Cat. No. 17600**  
CRL Chrome Deluxe Shower Squeegee



**Cat. No. S0RH1XX**  
CRL Polished Chrome Designer Series Sleeve-Over Robe Hook



**Cat. No. WSR1**  
CRL Bio-Clean Water Stain Remover



**Cat. No. EU33SC**  
CRL Clear Acetic Cure Silicone Sealant  
(Also available in black or white)



**Cat. No. EURTV408C**  
CRL Clear Neutral Cure Silicone Sealant  
(Also available in black or white)



**Cat. No. WCS1**  
CRL Water Clear Silicone



**Cat. No. EUCCS**  
CRL Crystal Clear Silicone Sealant



**Cat. No. EG310**  
CRL evergrip™ Mirror Adhesive Tubes



**Cat. No. GN100E**  
CRL Gunther Ultra/Bond Mirror Mastic

# Colour range\*

All CRL Frameless Shower Door products are available in a variety of beautiful stock finish to enhance the décor of the surrounding environments. Add the chosen colour code to a Cat No to complete your product code.

Note: Not all Finishes are available for every product, please call or consult [crlaurence.co.uk](http://crlaurence.co.uk) for product specific colour options.

<b>CH</b> Chrome	<b>SC</b> Satin Chrome (Matte)	<b>BSC</b> Brushed Satin Chrome	<b>BR</b> Brass
<b>SB</b> Satin Brass	<b>UBR</b> Ultra Brass	<b>ABR</b> Antique Brass	<b>BN</b> Brushed Nickel
<b>PN</b> Polished Nickel	<b>SN</b> Satin Nickel	<b>ABN</b> Antique Brushed Nickel	<b>ORB</b> Oil Rubbed Bronze
<b>ABRZ</b> Antique Bronze	<b>BBRZ</b> Brushed Bronze	<b>BCO</b> Brushed Copper	<b>PCO</b> Polished Copper
<b>ABCO</b> Antique Brushed Copper	<b>GP</b> Gold Plated	<b>GM</b> Gun Metal	<b>W</b> White
<b>BL</b> Black	<b>BS</b> Brushed Stainless Steel	<b>PS</b> Polished Stainless Steel	<b>CBA</b> Chrome/Brass Steel

\* The finishes shown are as close as possible to the actual item. Some images might look a little different when compared to the actual product.

# Colour range

See our range of colour finishes overleaf. Keep the flap open for easy reference.

Call FREE on 00 800 0421 6144

Fax FREE on 00 800 0262 3299



#### Manchester

Charles Babbage Avenue  
Kingsway Business Park,  
Rochdale, OL16 4NW, England  
Tel: +44 (0) 1706 863 600  
Fax: +44 (0) 1706 869 860  
[www.crlaurence.co.uk](http://www.crlaurence.co.uk)



#### Stuttgart

Boschstrasse 7  
D-74360 Ilfeld  
Germany  
Tel: +49 (0) 7062 915 93 15  
Fax: +49 (0) 7062 915 93 16  
[www.crlaurence.de](http://www.crlaurence.de)



#### Copenhagen

Stamholmen 70 Unit B,  
DK-2650 Hvidovre  
Denmark  
Tel: +45 36 72 09 00  
Fax: +45 36 70 33 35  
[www.crlaurence.dk](http://www.crlaurence.dk)



#### France

Boschstrasse 7  
D-74360 Ilfeld  
Germany  
Tel: +49 (0) 7062 915 93 15  
Fax: +49 (0) 7062 915 93 16  
[www.crlaurence.fr](http://www.crlaurence.fr)

**CNL**  
[crlaurence.co.uk](http://crlaurence.co.uk)



View Our Full Range of  
Frameless Shower Door Hardware  
and Supplies...

Our EUSD12 Frameless Shower Door Hardware  
and Supplies Catalogue

- Hinges
- Pull Handles
- Knobs
- Towel Bars
- Clamps
- Headers
- U-Channels
- Tapes
- Wipes
- Door Kits

You may also be interested in...

EUAH11 Architectural Hardware  
'All Glass' Entrance Systems Catalogue

- Architectural Metals
- Door and Sidelite Rails
- Door Closers
- Centre Locks
- Glass Clamps
- Headers and Channels
- Ladder Pulls
- Locking Hardware
- Door Closers and Hinges
- Patch Hardware
- Pivot Door Systems
- Push/Pull Handles
- Sliding and Stacking Glass Door Systems
- Spider Fittings
- Standoff Systems

Catalogues are available to download  
or view online at [crlaurence.co.uk](http://crlaurence.co.uk)  
or [crlaurence.de](http://crlaurence.de)